

# MUEBLE PARA SALA DE REUNIONES

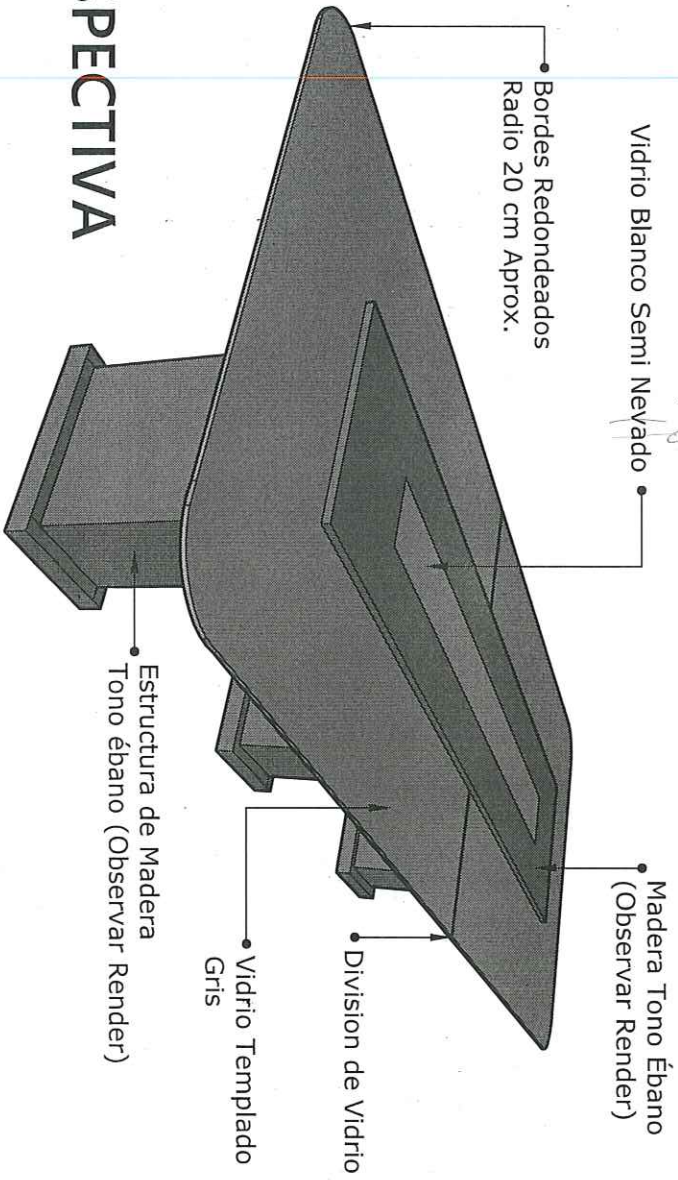

## PERSPECTIVA

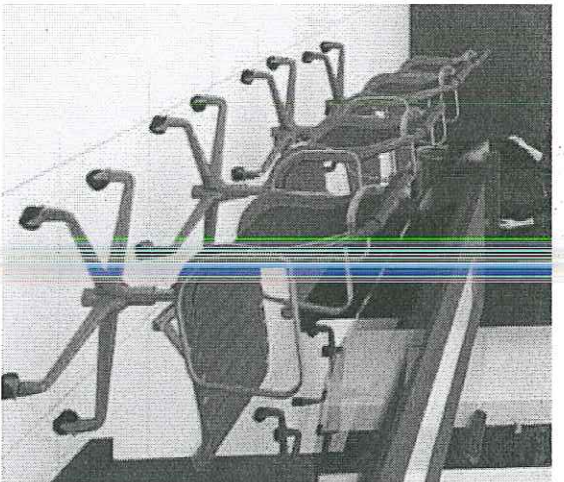
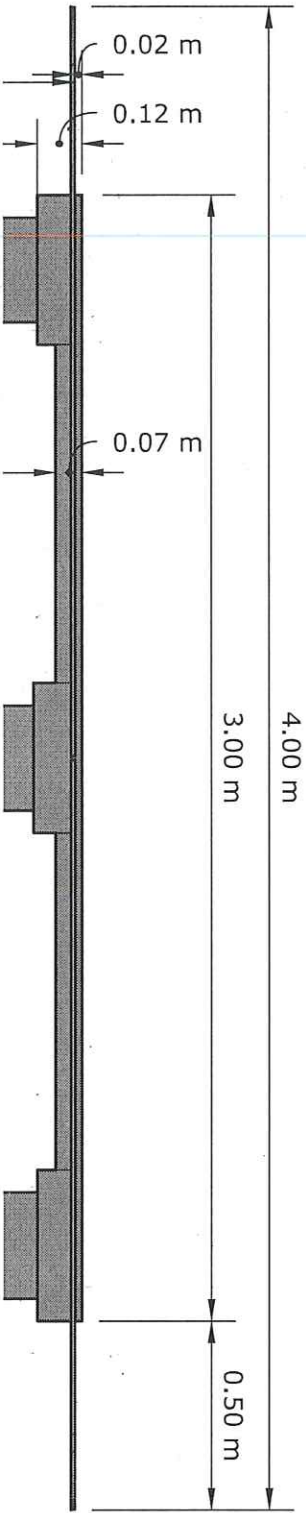

Acabado

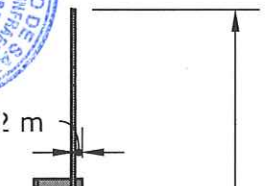

# ESCRITORIO PARA OFICINA

3 Gavetas magnéticas a presión

Estructura de Madera con acabado Tono Ebano (Observar Render)

Refuerzo Asimilando Acero Inoxidable

Formica Gris Oscuro Semi Brillante

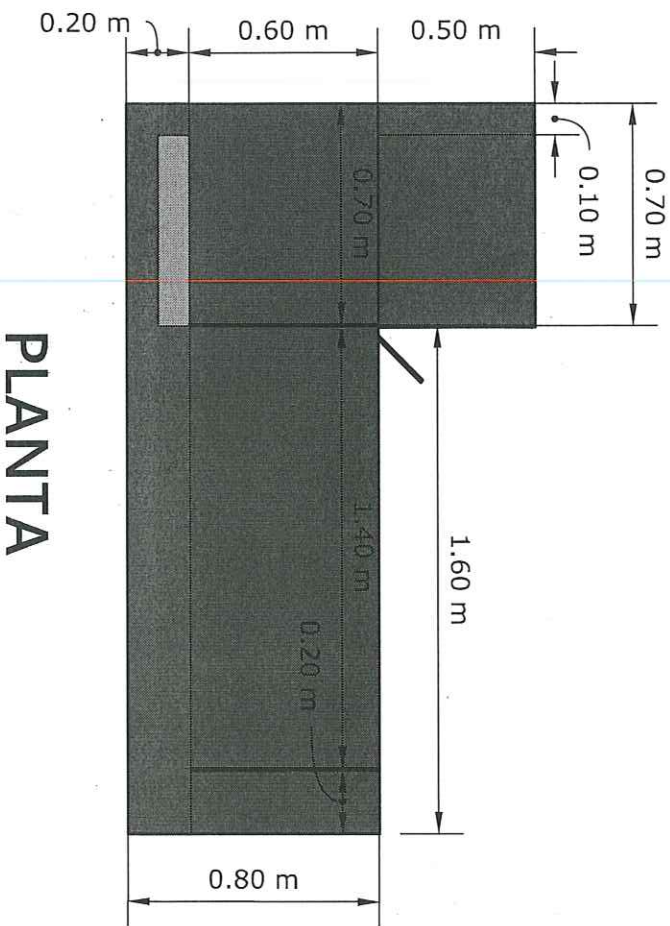

## PERSPECTIVA

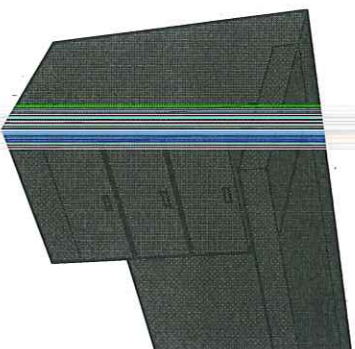

2.30 m

E





# MESA PARA SALA DE ESTAR

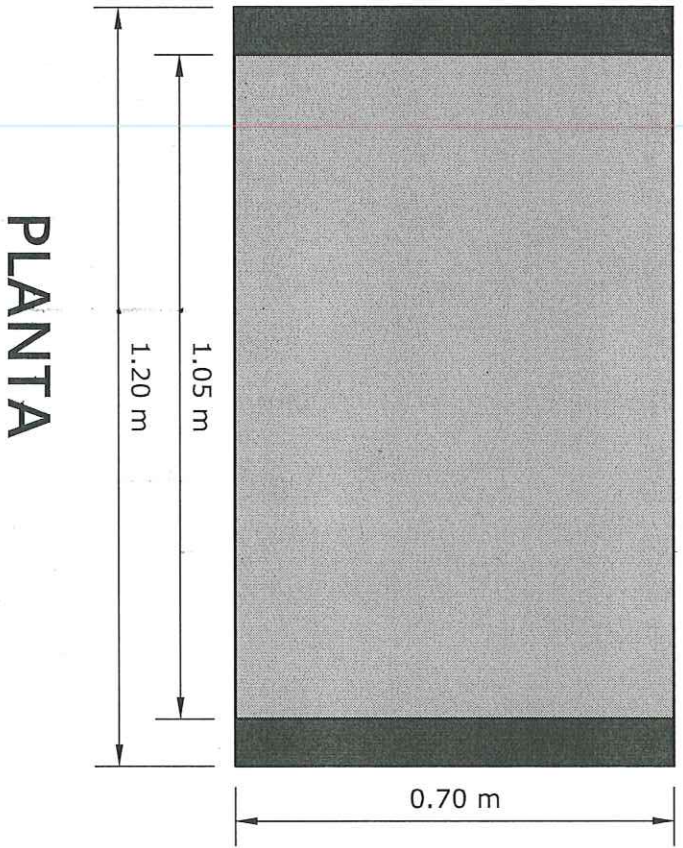

PLANTA

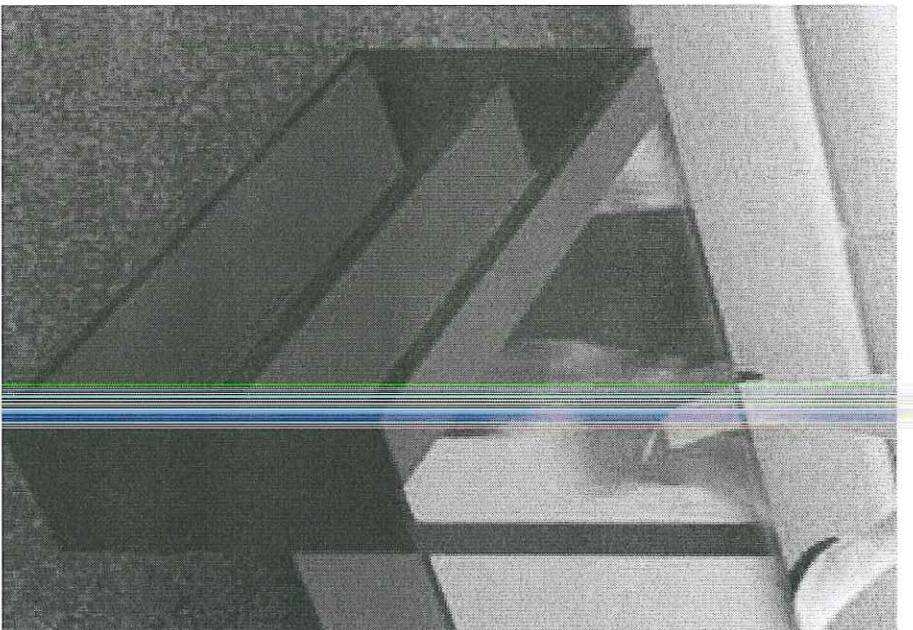

Acabado



# SILLON DOBLE PARA SALA DE ESTAR

## FRONTAL

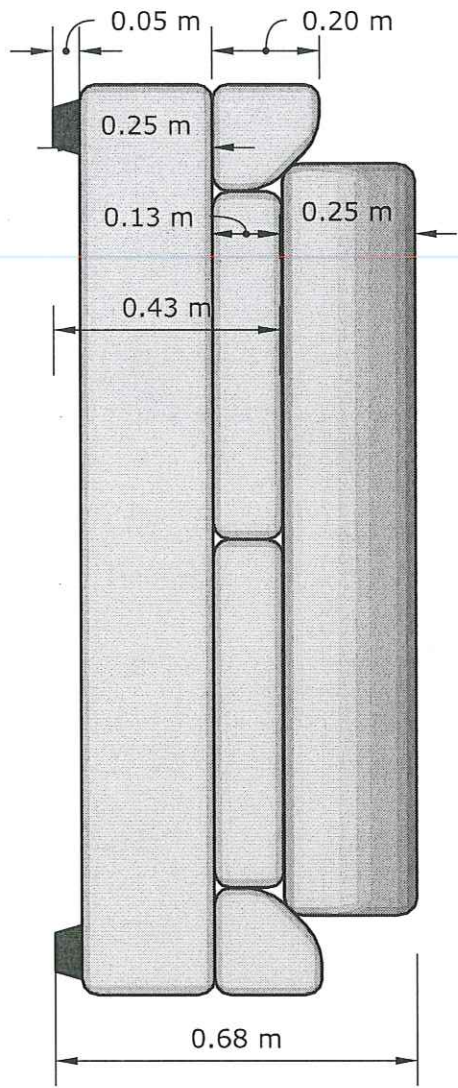
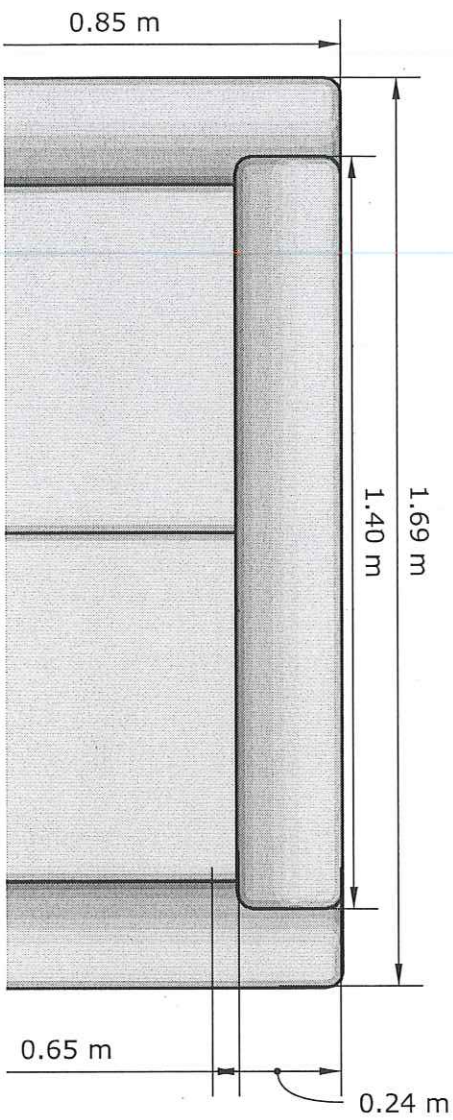

## LATERAL

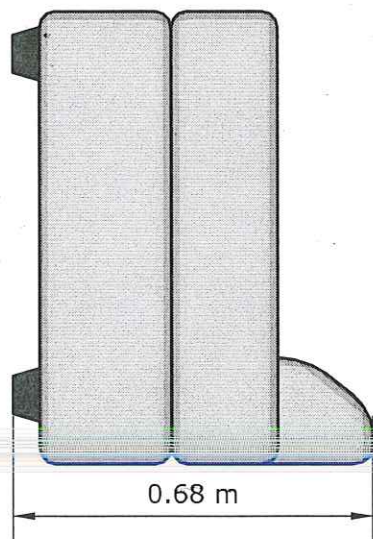
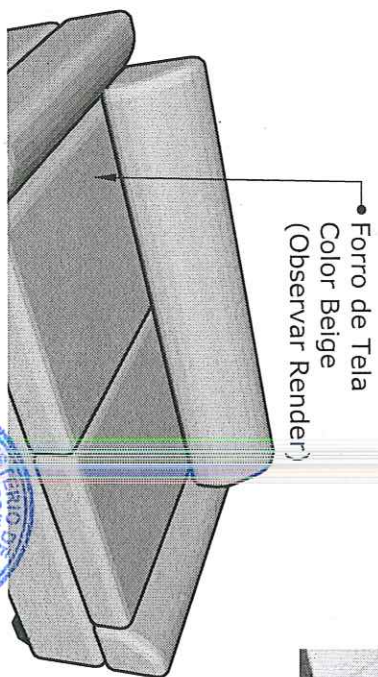



# SILLON PARA SALA DE ESTAR - CANTIDAD 2

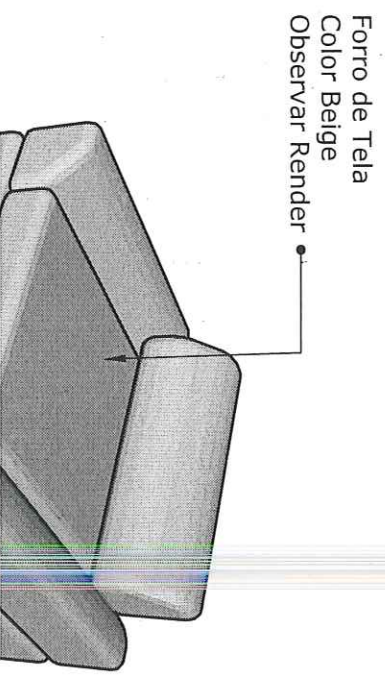
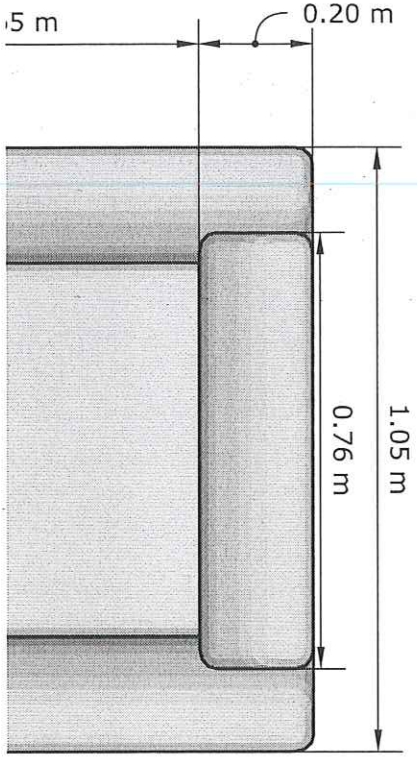
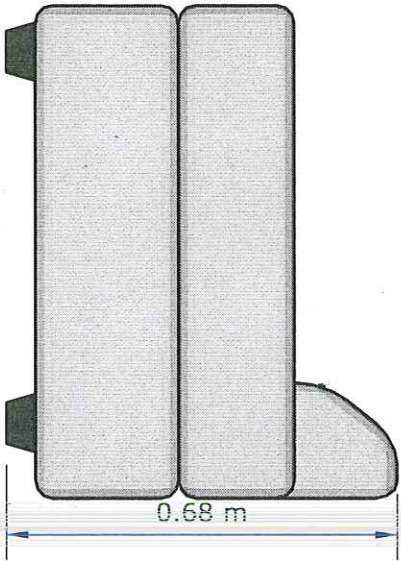
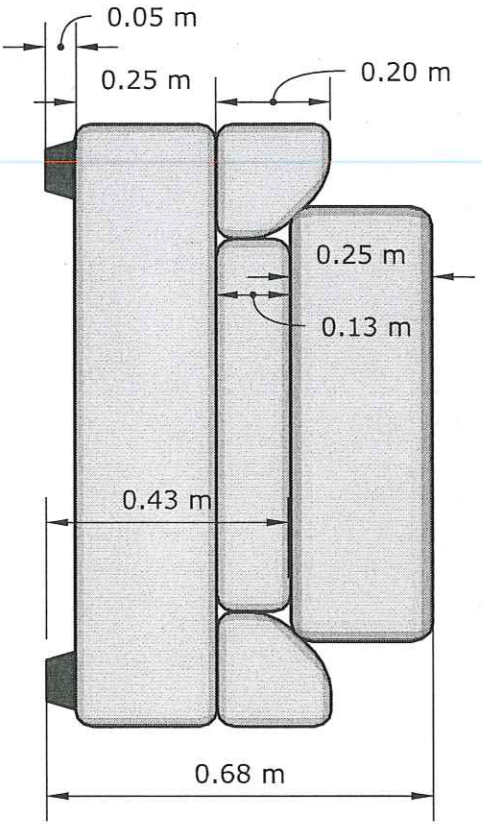

# ESTACION DE CAFE

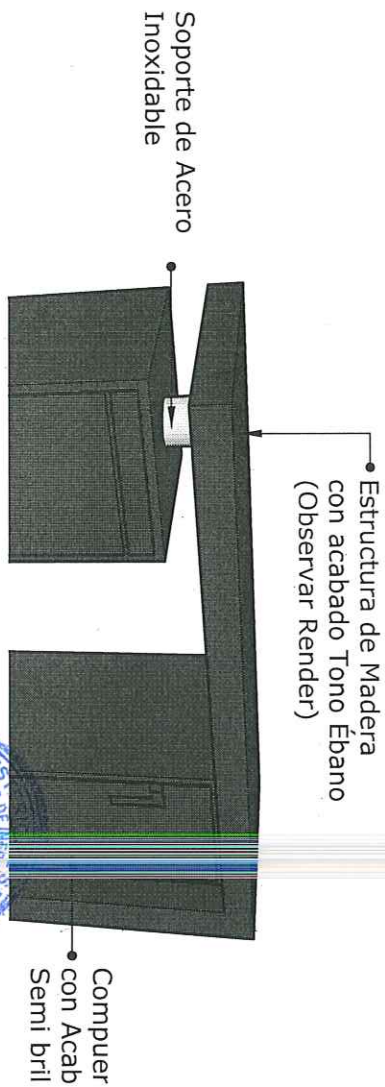
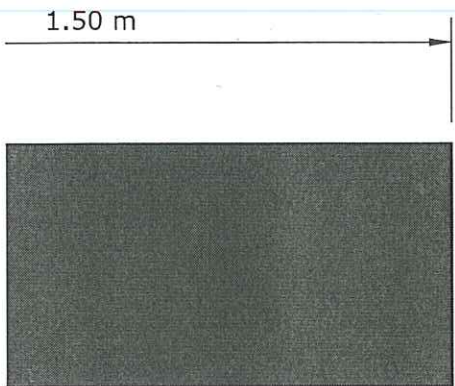
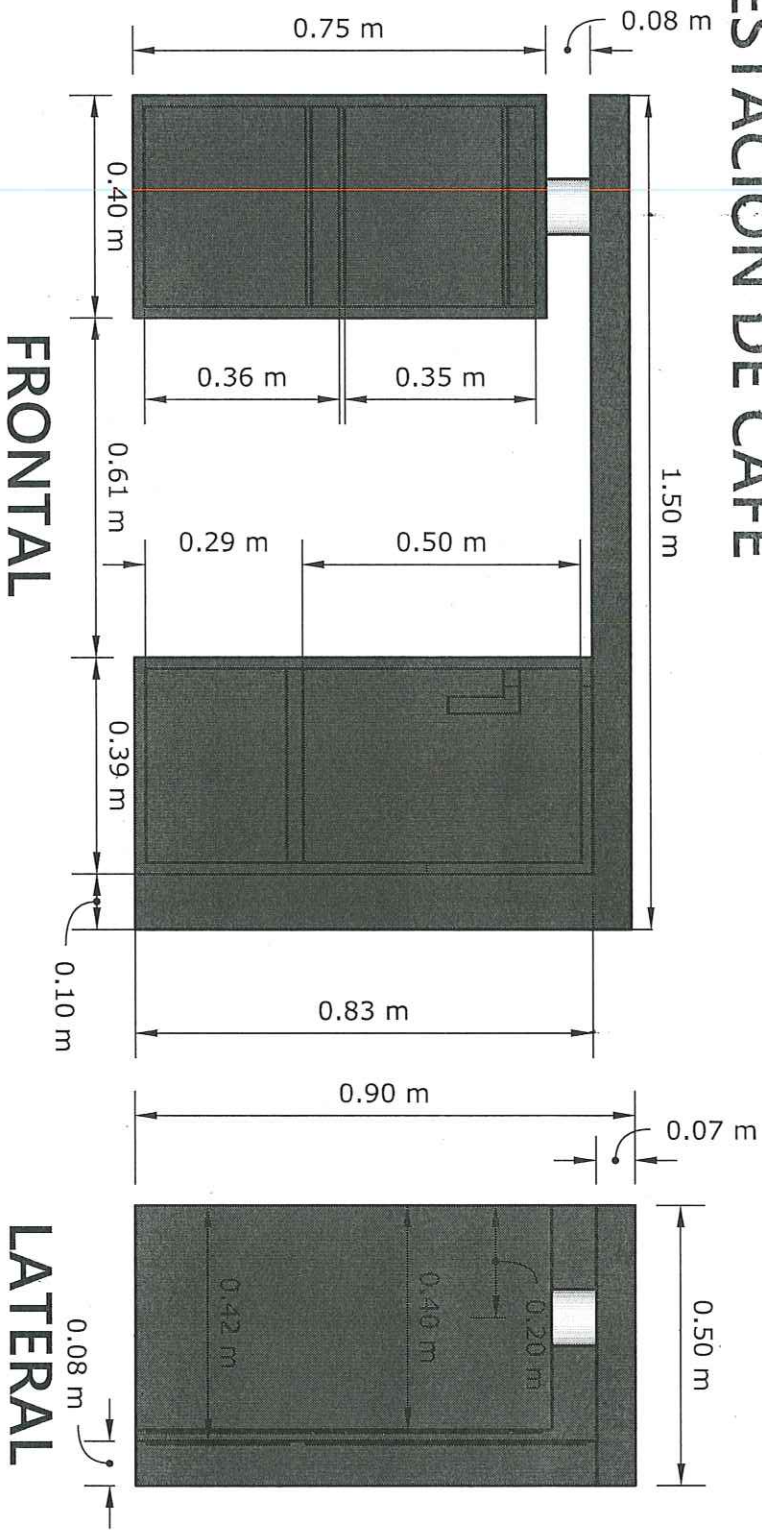



# MESA REDONDA DE MADERA

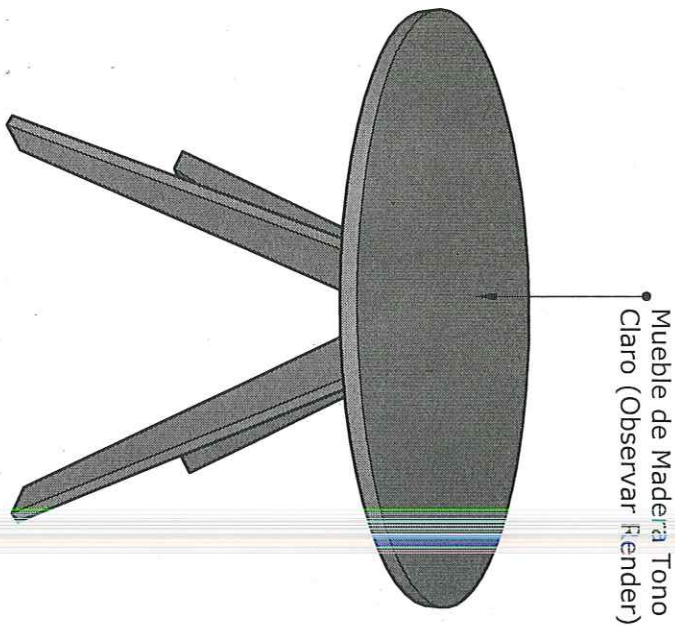
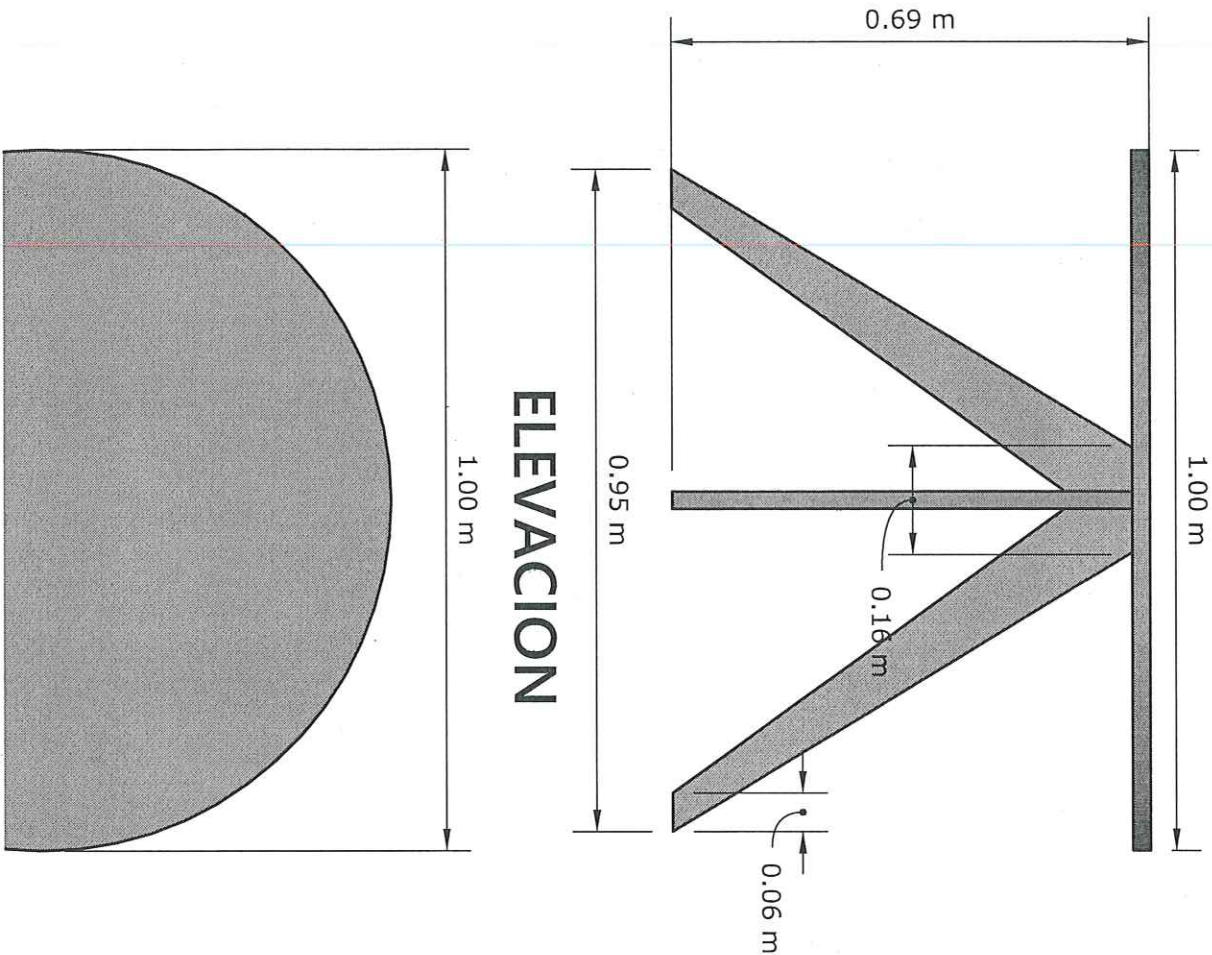

*[Handwritten signature]*

**MINISTERIO DE SALUD**  
UNIDAD DE DESARROLLO DE LA INFRAESTRUCTURA SANITARIA  
REPUBLICA DE EL SALVADOR